

Assembly Instructions

English



Grundig SAT Systems

Head-End IP Converter to COFDM MPTS to COFDM

HMPT 1000 T



GSS
Grundig SAT Systems GmbH
Beuthener Strasse 43
D-90471 Nuremberg

Phone: +49 (0) 911 / 703 8877
Fax: +49 (0) 911 / 703 9210
E-mail: info@gss.de
Internet: <http://www.gss.de>

Contents

1	Safety regulations and notes	4
2	General information	5
2.1	Packing contents	5
2.2	Meaning of the symbols used	5
2.3	Technical data	5
2.4	Description	6
2.4.1	Input signal path "INROUTE"	7
	Menu setting "A=1 B=2"	7
	Menu setting "A+B=1 2=OFF"	7
2.4.2	Output signal path "OUTROUTE"	8
	Menu setting "1=>MA 2=>MB"	8
	Menu setting "1=>ASI MA=OFF"	8
	Menu setting "2=>ASI MB=OFF"	8
2.4.3	General	9
2.5	Software query	10
2.6	How the TPS module works	10
3	Assembly	11
3.1	Installing the cassette	11
3.2	EMC regulations	11
3.3	Cassette overview	12
3.4	Connecting the cassette	13
3.5	Retrofitting a CA module	13
4	The control panel at a glance	14
4.1	Menu items	14
4.2	Control panel	15
5	Programming	15
5.1	Preparation	15
5.2	Programming procedure	16
	Channel strip "A" (without CA module) and channel strip "B"	16
	Channel strip "A" with CA module	19
5.3	Programming the cassette	20
	Selecting the cassette, displaying the software version	20
	Setting the Ethernet parameters	21
	Setting the IP address of the cassette	21
	Setting the address range	22
	Setting the address of the gateway	22
	Setting the UDP port	22
	Selecting the input signal path	23
	Selecting the output signal path	23
	Setting the ASI transfer rate	24
	Setting the ASI options	24
	Selecting the channel strip	25
	Selecting channel / frequency setting	25

Setting the output channel.....	26
Setting the output frequency.....	26
Switching the modulator off or on.....	26
Adjusting the output levels of the channel strips.....	27
Selecting the input transport stream.....	28
Switching the IP address off or on.....	28
Selecting the transmission protocol.....	28
Setting the port number.....	28
Setting the IP address of the input transport stream.....	29
Setting the station filter.....	30
COFDM parameters.....	33
Setting the output signal.....	36
Setting the transmission parameters.....	37
Setting the transmitter identification.....	38
Displaying the output data rate.....	38
Setting a substitute signal.....	39
Setting the transport stream / ORGNET-ID.....	40
Network Information Table (NIT).....	40
Setting the network/operator identification.....	41
Deleting a PID.....	42
Renaming a PID.....	42
Factory reset.....	43
Saving settings.....	43
5.3.1 Setting the HF receiving stage.....	44
Setting the LNB oscillator frequency.....	44
Setting the input symbol rate.....	44
Setting the DVB mode.....	44
Setting the input frequency.....	45
Testing the signal to noise ratio.....	46
5.3.2 Operation with a CA module.....	47
Setting the PID monitoring.....	47
Configuring the CA module.....	47
Descrambling services.....	49
6 Final procedures.....	50
7 Channel and frequency tables.....	51

1 Safety regulations and notes



- Assembly, installation and servicing should be carried out by authorised electricians.
- Switch off the operating voltage of the system before beginning with assembly or service work or pull out the mains plug.
- Do not perform installation and service work during thunderstorms.
- Install the system so it will not be able to vibrate...
 - in a dust-free, dry environment
 - in such a manner that it is protected from moisture, fumes, splashing water and dampness
 - somewhere protected from direct sunlight
 - not within the immediate vicinity of heat sources
 - in an ambient temperature of 0 °C to +50 °C. In case of the formation of condensation wait until the system is completely dried.
- Ensure that the head-end station is adequately ventilated. Do not cover the ventilation slots.
- Beware of short circuits
- No liability is accepted for any damage caused by faulty connections or inappropriate handling.
- Observe the relevant standards, regulations and guidelines on the installation and operation of antenna systems.
- The standards IEC/EN/DIN EN 50083 and IEC/EN/DIN EN 60728 must be observed.
- **For further information please read the assembly instructions for the head-end station used.**
- **Test the software versions of the head-end station and the cassette and update them if necessary. The current software versions can be found at "www.gss.de".**



Take action to prevent static discharge when working on the device!



Electronic devices should never be disposed of in the household rubbish. In accordance with directive 2002/96/EC of the European Parliament and the European Council from January 27, 2003 which addresses old electronic and electrical devices, such devices must be disposed of at a designated collection facility. At the end of its service life, please take your device to one of these public collection facilities for proper disposal.

2 General information

2.1 Packing contents

- | | |
|------------------------------|-------------------------------|
| 1 Cassette HMPT 1000 T | 1 HF cable |
| 1 CD (assembly instructions) | 1 Brief assembly instructions |

2.2 Meaning of the symbols used



Important note



General note

- Performing works

2.3 Technical data

The devices meet the following EU directives:

2006/95/EC, 2004/108/EC

The product fulfils the guidelines and standards for CE labelling.

Unless otherwise noted all values are specified as "typical".

HF input

Frequency range:..... 925 ... 2150 MHz

Level range: 60 dB μ V ... 80 dB μ V

Return loss: > 8 dB

DVB-S modes: QPSK $1/2, 2/3, 3/4, 5/6, 7/8$

DVB-S2 modes: QPSK $1/2, 3/5, 2/3, 3/4, 4/5, 5/6, 8/9, 9/10$

8PSK $3/5, 2/3, 3/4, 5/6, 8/9, 9/10$

Symbol rate DVB-S:..... QPSK: 2 ... 45 MSymb/s

Symbol rate DVB-S2:..... QPSK: 10 ... 30 MSymb/s

8PSK: 10 ... 31 MSymb/s

Impedance:..... 75 Ω

COFDM modulator

Signal processing: DIN EN 300744

Transmission modes:..... 2k, 4k, 8k

Types of modulation: QPSK, 16 QAM, 64 QAM

Code rates:..... $1/2, 2/3, 3/4, 5/6, 7/8$

Guard intervals:..... $1/4, 1/8, 1/16, 1/32$

HF output

Frequency range:..... 42.0 MHz ... 860.0 MHz
Channels: C5 ... C12, C21 ... C69
Types of modulation: QPSK, 16 QAM, 64 QAM
Output level: 96 dB μ V
Output impedance: 75 Ω

LAN interface

Standard: 100-BASE-T
Data rate: \leq 80 MBit
Protocols: UDP (User Data Protocol),
RTP (Real-Time Transport Protocol)

ASI interfaces

Standard: DIN EN 50083-9
Format: MPEG ISO IEC 13818-1
User data rate: 2 ... 90 Mbit/s
Impedance: 75 Ω
Level (input / output): 800 mV_{pp} \pm 10%
Return loss (input): $>$ 17 dB (5 ... 270 MHz)

Connections

SAT input: 1 F socket
HF output: 1 IEC socket
ASI output: 1 BNC socket, 75 Ω
LAN: 1 RJ 45 socket
Connection strip (10-pin): for supply voltages and control circuits
RS 232 socket: serial interface for software update
Common Interface: 1 (several services can be decoded)

2.4 Description

The cassette is a MPTS / COFDM-converter, which converts the transport stream fed via the LAN interface and the transport stream of the receiving stage in channel strip "A", containing services modulated according to DVB-S / DVB-S2 standard, into one or two COFDM-modulated cable signals dependent on the input and output signal paths. To do this the transport stream fed via the LAN interface can be combined with the transport stream of the receiving stage via the TPS module of the channel strip "A".

The cassette has one SAT IF input and one HF output. Additionally it is equipped with a LAN interface and an ASI output (ASI – Asynchronous Serial Interface

according to DIN EN 50083-9).

For operating the cassette in a LAN network an IP address can be allocated to the cassette.

The signal path is set in the menu items input signal path "**INROUTE**" and output signal path "**OUTROUTE**".

2.4.1 Input signal path "INROUTE"

Menu setting "A=1 B=2"

The transport streams of the receiving stage of channel strip "A" and of the LAN input of channel strip "A" generate optionally the transport stream 1. The transport stream of the LAN input of channel strip "B" generate the transport stream 2.

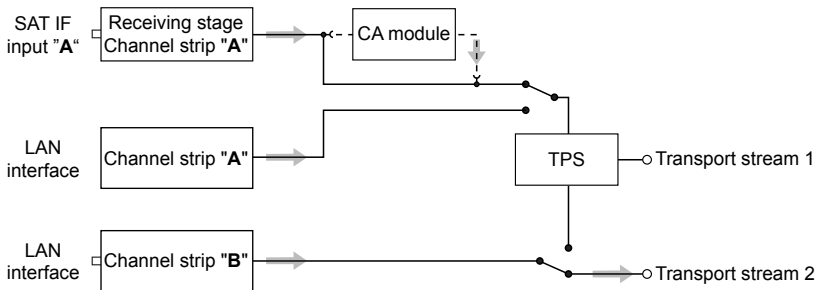

Menu setting "A+B=1 2=OFF"

The transport streams of the receiving stage of channel strip "A" and optionally of the LAN input of channel strip "A" generate in conjunction with the transport stream of the LAN input of channel strip "B" the transport stream 1. The transport stream 2 is switched off.

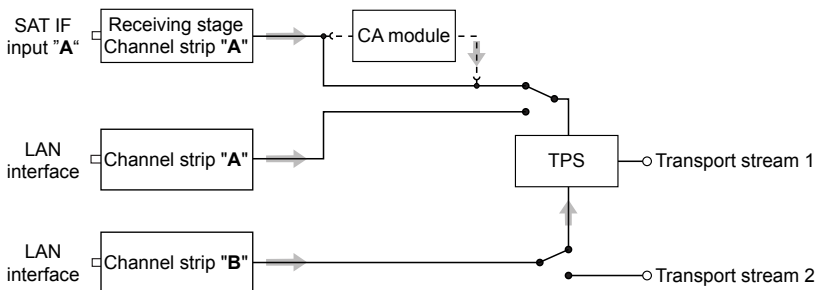

2.4.2 Output signal path "OUTROUTE"

Menu setting "1=>MA 2=>MB"

Transport stream 1 is made available via modulator "A", transport stream 2 via modulator "B".

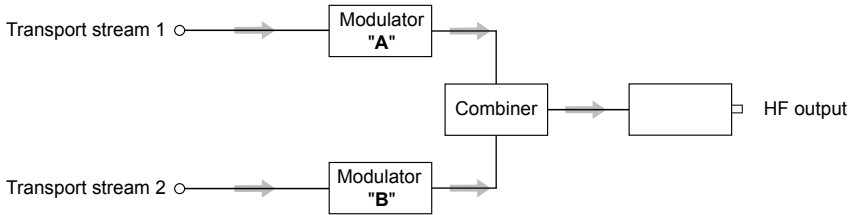

Menu setting "1=>ASI MA=OFF"

Transport stream 1 is made available via the ASI output. The transport stream 2 is provided via modulator "B" and the HF output. The signal path via modulator "A" (MA) is switched off.

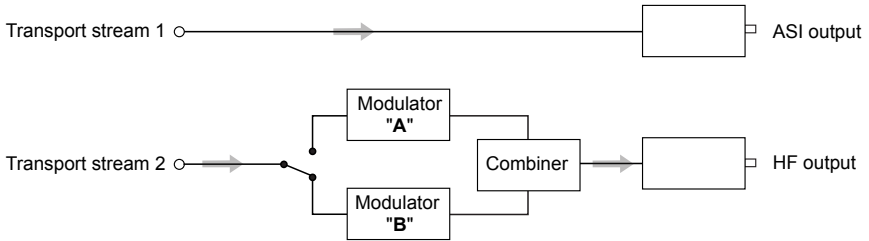

Menu setting "2=>ASI MB=OFF"

Transport stream 1 is made available via modulator "A" and the HF output, transport stream 2 via the ASI output. The signal path via modulator "B" (MB) is switched off.

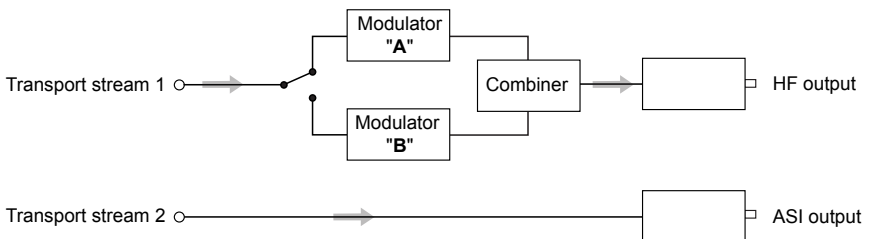

2.4.3 General

The cassette is equipped with two channel strips ("**A**" and "**B**"). The "**A**" channel strip has a digital SAT tuner and can process both the transport stream fed in via the LAN interface and the transport stream from the SAT tuner. Using an appropriate CA module, encoded services coming from the SAT tuner can be decoded in channel strip "**A**". The "**B**" channel strip only processes the transport stream fed in via the LAN interface. The transport streams are directed to the ASI output or the output converter depending on the set output signal route "**OUTROUTE**" via the digital signal processing levels. The HF output signals are sent through the HF output on the cassette to the output collector. The common output level of the channel strips can be set in the output collector on the head-end station.

An LED in channel strip "**A**" provides an indication of the signal quality for the SAT IF input signal and shows whether the modulator of the channel strip is activated (LED lights up) or deactivated. The quality of the transport stream being received is also shown in the display ("**CN...**").

The integrated TPS module (Transport Stream Processing) processes the data from the transport streams.

The channel strips are indicated in the head-end station display with "**Bx ...A**" and "**Bx ...B**". The control of the cassette takes place via the control unit of the head-end station.

When the head-end station is switched on, the two-line LC display shows the software version of the control unit.

To operate this cassette the software version of the control unit must be "**V 41**" or higher. You can find the current operating software for the control unit and the cassette, the required update software "**BE-Flash**" and the current assembly instructions on the website "www.gss.de".

The cassette is designed for use in the following head-end stations:
STC 1200, STC 316, STR 19-8 and PST 19-1.

2.5 Software query

Control unit

If necessary, you can activate the indication of the software version of the control unit manually:

- Press any two keys on the control unit of the head-end station simultaneously until the display goes dark and the software version, e.g. "**V 41**" appears.

Cassette

After activating the cassette the software version of the cassette is displayed (see page 20).

2.6 How the TPS module works

After decoding QPSK- or 8PSK-modulated signals, the demodulated transport stream can be accessed via the integrated TPS module. This transport stream, also called data stream, contains several services with the appropriate data components (video, audio, data and service information), which can be changed using the TPS module.

In the station filter services can be deleted. This reduces the output data rate. Additionally services of the different transport streams can be assembled to a new transport stream.

The transport stream contains data in the form of tables which the receivers evaluate and require for convenient use. The TPS module can adjust the "Network Information Table" (NIT) to accommodate the new service data. The "NIT" contains data which is required by the set-top boxes for the automatic search feature.

Some network operators transmit an operator ID in the transport stream (e.g. visAvision). By changing the CAT the operator ID can be adjusted to the demands.

3 Assembly

3.1 Installing the cassette



- Ensure the head-end station is mounted so it will not be able to vibrate. Avoid, for example, mounting the head-end station onto a lift shaft or any other wall or floor construction that vibrates in a similar way.
 - Before installing or changing a cassette unplug the power cable from the mains power socket.
- Remove the fastening screws ① of an unoccupied slot from the bracket of the head-end station.
 - Insert the cassette in this slot and push it into the housing.
 - Align the cassette and apply slight pressure to connect it to the connections of the board and the HF bus bar.
 - Fasten the cassette with the screws ①.

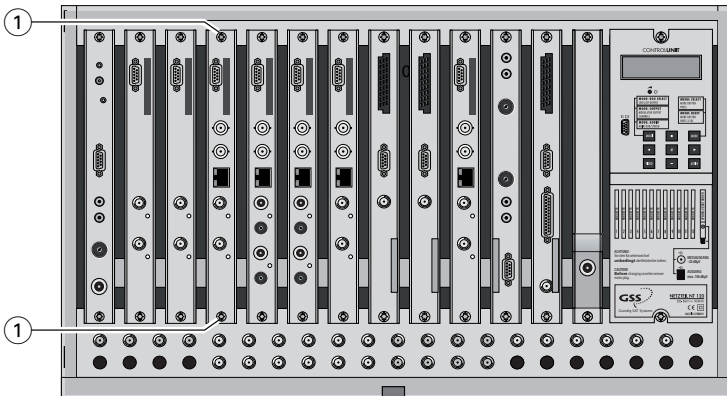

3.2 EMC regulations



To comply with the current EMC regulations, it is necessary to connect the lines leading in and out of the head-end station using cable terminals. When mounting the cassette in a head-end station which is installed in a 19" cabinet, make sure the connections leading in and out for the 19" cabinet are made using cable terminals.



The attenuation of shielding of the connection lines for ASI and antenna must meet the requirements for "Class A".

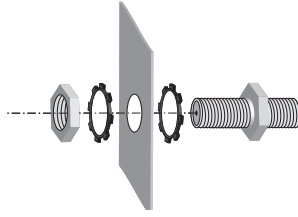

- Insert the required number of cable terminals in the openings provided in the head-end station or in the 19" cabinet.
 → Cable terminals are not included in the scope of delivery.



Tighten the nuts of the cable terminals until the teeth on the lock washers put under have penetrated the exterior coating and a good connection is made between the housing / 19" cabinet and cable terminals.

3.3 Cassette overview

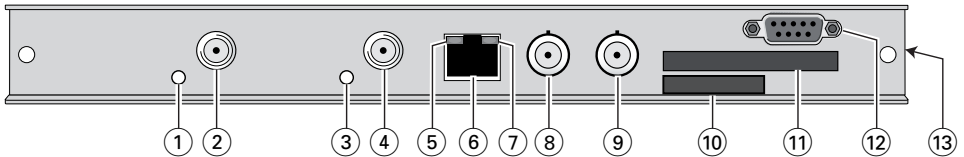

- ① Not used
- ② Not used
- ③ Status LED of channel strip "A"
- ④ SAT IF input of channel strip "A"
- ⑤ Status LED of the LAN interface (yellow LED – data transfer)
- ⑥ LAN socket
- ⑦ Status LED of the LAN interface (green LED – network connection)
- ⑧ Not used
- ⑨ ASI output
- ⑩ Type label
- ⑪ Slot for a CA module
- ⑫ D-SUB socket "RS 232"

The operating software of the cassette can be updated via the 9-pin D-SUB socket "RS 232" using a PC or notebook and the software "**BE-Flash**".

You can find the current operating software on the website "www.gss.de".

- ⑬ MAC address

3.4 Connecting the cassette

- Connect the SAT IF input cable to the SAT IF input ④ (channel strip "A"), (fig. chapter 3.3).
- Connect the LAN socket ⑥.
- Connect the ASI output ⑨ to the peripheral ASI device.

3.5 Retrofitting a CA module

The cassette is equipped with a common interface. It allows you to connect a CA module for various scrambling systems and service providers. Scrambled services (channels) can only be descrambled with a CA module suitable for the scrambling system and the corresponding smart card. The smart card contains all the information for authorisation, descrambling and subscription.



- Check with the distributor or manufacturer of the CA module to be used to ensure that it is suitable for descrambling several services.
- **The hardware and software of this cassette have been thoroughly prepared and tested.**

Any changes made by service providers in the data structures might impair or even prevent this function.

- When working with the CA module, please read the corresponding operating manual from the respective provider.
- Insert the smart card ① into the CA module ② so that the chip ③ on the smart card faces the thicker side (top) of the CA module.
- Insert the CA module into the guide rails of the CA slot ④ with the top side of the CA module facing the top side of the cassette.
- Push the CA module without canting into the guide rails of the CA slot ④ and contact it to the common interface.

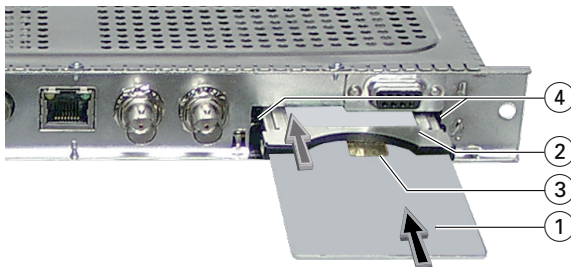

4 The control panel at a glance

4.1 Menu items

Program the cassette using the buttons on the control unit of the head-end station. The two-line display of the control unit then shows the menus. The parameters and functions to be set are underlined.

Use the **MODE** key to select the following main menu items:

- Ethernet parameters
- Input signal path
- Output signal path
- Channel strip
- Channel / frequency selection
- Output channel / output frequency
- Output level
- Selecting the input
- IP parameters
- IP address of the input transport stream
- LNB oscillator frequency
- Input symbol rate
- Input frequency
- Station filter
- CA module (if available)
- Output signal
- Transmission parameters
- Station identification
- Stuffing
- Substitute signal
- Transport stream / ORGNET-ID
- Network Information Table (NIT)
- Network/operator identification
- Deleting a PID
- Renaming a PID
- Factory reset

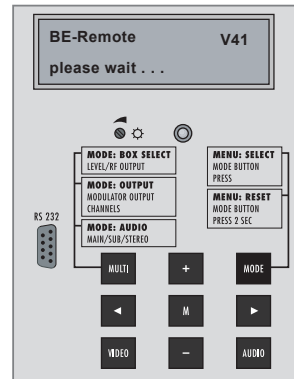

4.2 Control panel

The key pad on the head-end station is used to scroll through the menus:

MODE	scrolls forward through the menus.
◀ / ▶	select parameters in the menus.
+ / -	set values, initiate actions.
MULTI	selects sub-menus.
AUDIO	scrolls backward through the menus.
M	saves all entries.

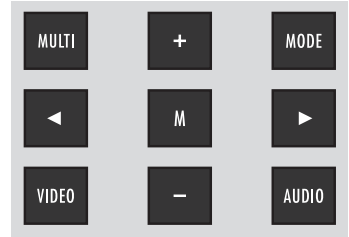

5 Programming

5.1 Preparation

- Test the software versions of the head-end station and the cassette and update them if necessary.
The current software versions can be found on the website "www.gss.de".
- Connect the test receiver to the HF output or the test output of the head-end station.
- Set the output channel / output frequency of the cassette (see page 26) and adjust the TV test receiver to this channel / frequency.
- Switch on the channel strip (modulator) if necessary (see page 26). A luminescent status LED indicates if the channel strip is switched on.



Status-LED
Kanalzug "A"

- Balance the output levels of the channel strips "A" and "B" if the difference in level is ≥ 1 dB (page 37).

5.2 Programming procedure

Channel strip "A" (without CA module) and channel strip "B"

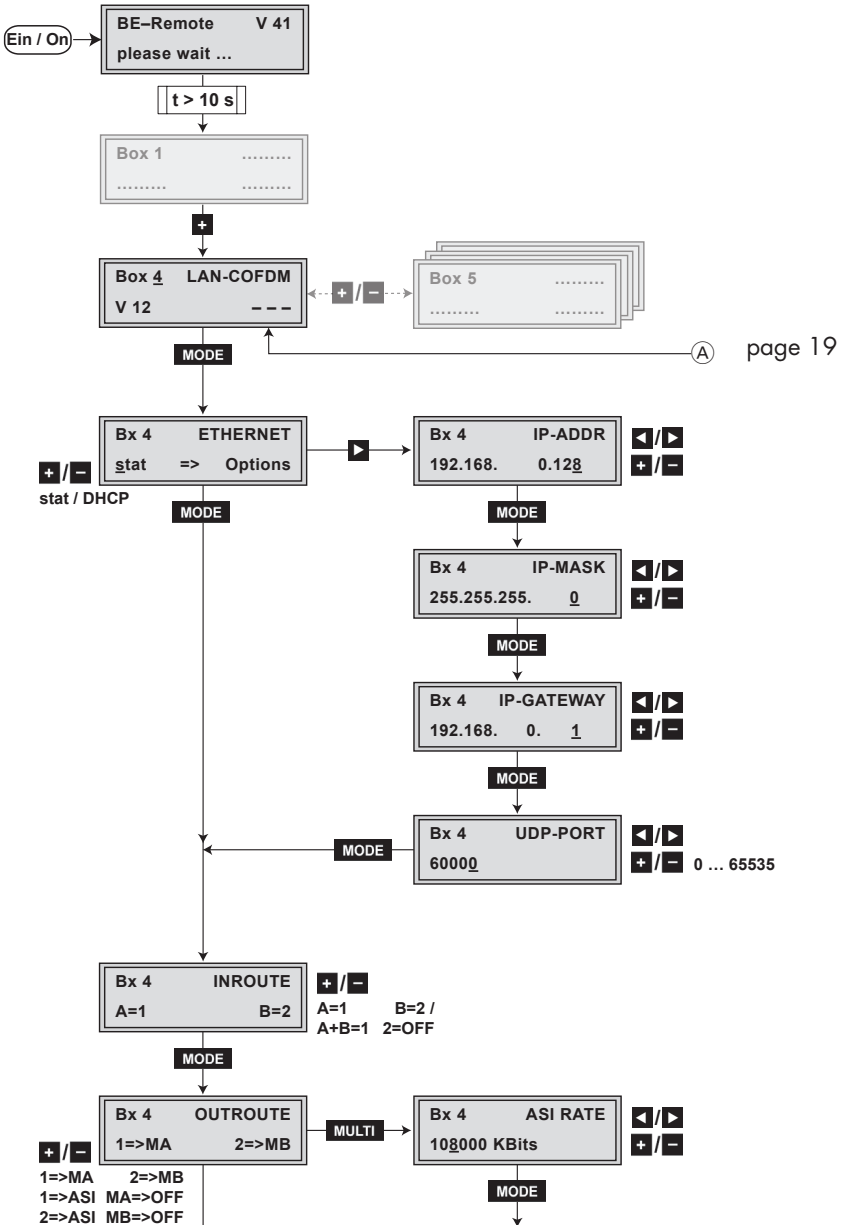

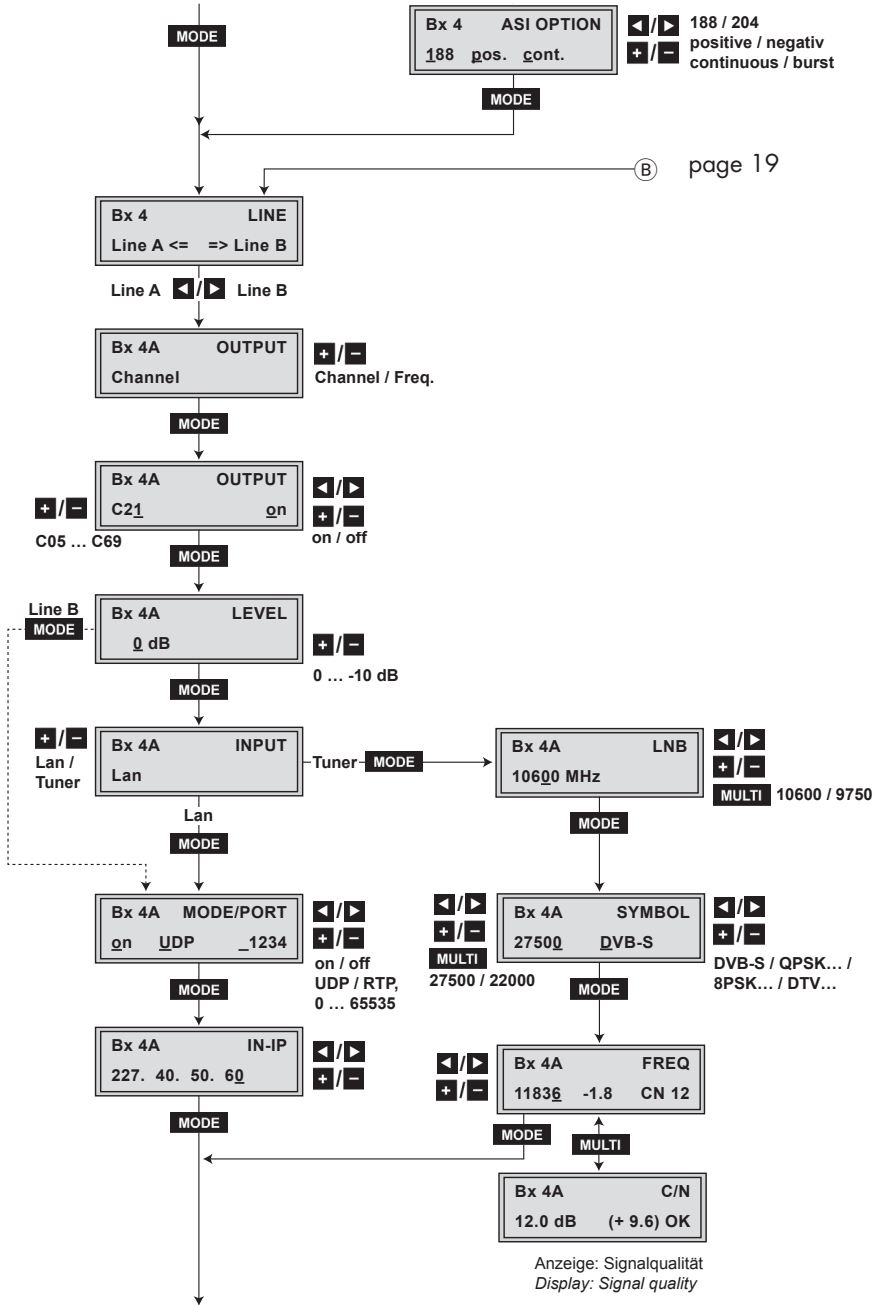

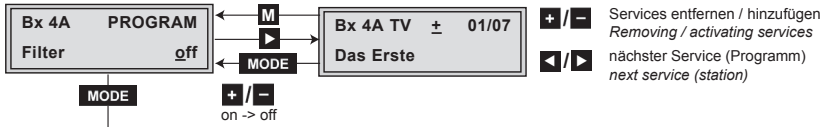

Kanalzug "A"
ohne CA-Modul
Channel strip "A"
without CA module
Kanalzug "B"
Channel strip "B"

Kanalzug "A" mit CA-Modul
Channel strip "A" with CA module

page 19

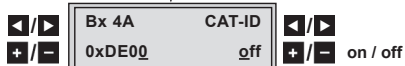
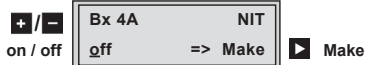
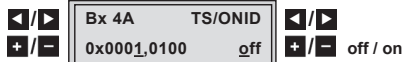
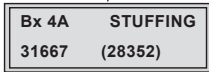
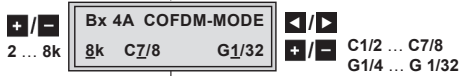
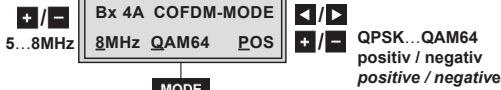

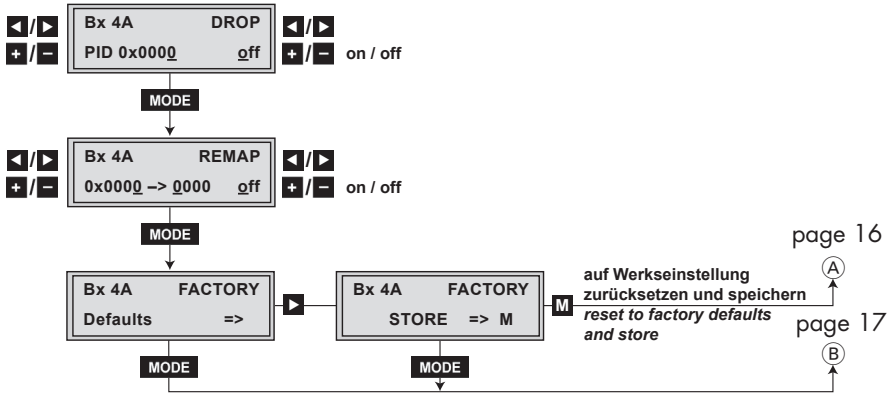

Channel strip "A" with CA module

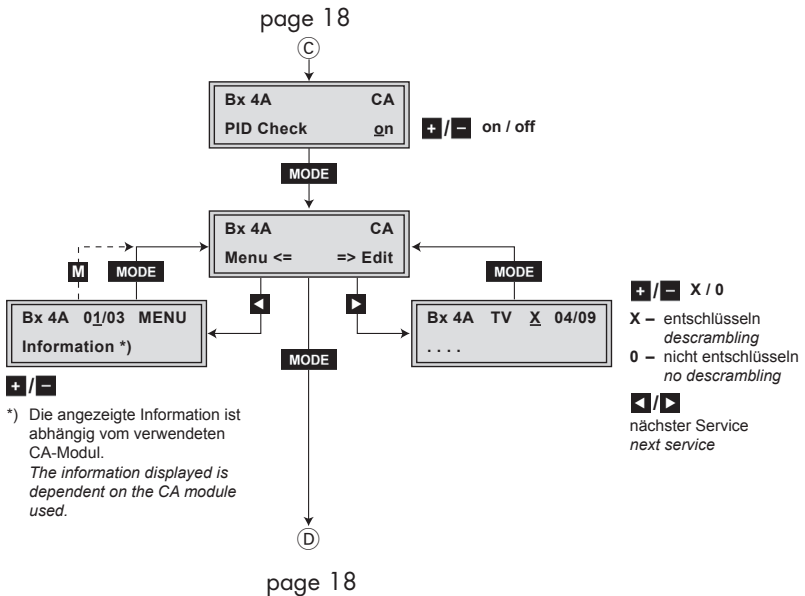

5.3 Programming the cassette

- Pressing the **MODE** button for longer than 2 seconds cancels the programming procedure. This takes you back to the program item "Selecting the cassette" from any menu. Any entries that have not been saved are reset to the previous settings.
- Entries in the menus can be saved by pressing the **M** key. You are taken back to the "Selecting the cassette" menu item.
- Using the **AUDIO** button previous menus can be activated.
- Switch on the head-end station
 - The display shows the software version (e.g. V 41)
 - The processor reads the cassettes' data (approx. 10 seconds).

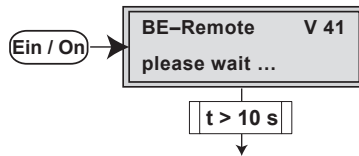

Selecting the cassette, displaying the software version

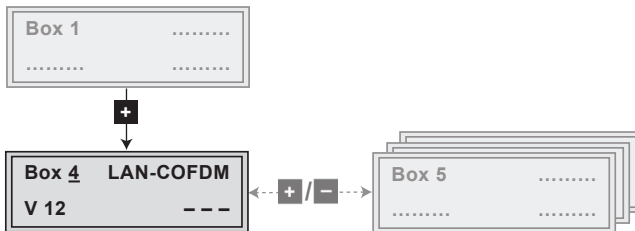

- Select the cassette you want to program (e.g. **Box 4**) by repeatedly pressing the button **+** if necessary.
 - The display shows the menu "**Box 4 LAN-COFDM**":
 - "**Box 4**" stands for slot 4
 - "**LAN-COFDM**" type of cassette
 - "**V 12**" software version of the cassette
- Press the **MODE** button.
 - The "Setting the Ethernet parameters" – "**ETHERNET**" menu is activated.

Setting the Ethernet parameters

In this menu you specify whether the Ethernet parameters for the cassette are entered automatically by a connected server ("**DHCP**"), or whether you want to enter them manually ("**stat**"). To assign the cassette uniquely, each IPTV cassette must be allocated its own IP address.



- Press the **+** / **-** buttons to select manual setting ("**stat**") or automatic setting ("**DHCP**") of the Ethernet parameters.
 - Press the **▶** button to activate the setting options ("**Options**").
- The "Setting the IP address of the cassette" – menu "**IP-ADDR**" is activated.

Setting the IP address of the cassette

If you choose to enter the Ethernet parameters manually, set the IP address of the cassette in this menu.

If "**DHCP**" is selected, the "**IP-ADDR**", "**IP-MASK**" and "**IP-GATEWAY**" sub-menus display the parameters that were assigned automatically by a connected server. If a server is not connected, " 0. 0. 0. 0*" appears in the corresponding menu. The star " * " in the display means that the data is provided by a DHCP server.

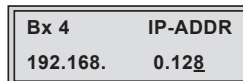

- Use the **◀** / **▶** buttons to place the cursor under the digit of the IP address displayed to be set and use **+** / **-** to set the IP address wished.
 - Press the **MODE** button.
- The "Setting the address range" – "**IP-MASK**" menu is activated.

Setting the address range

In this menu you define the address range for the cassettes connected to the LAN network.

Bx 4	IP-MASK
255.255.255.	0

- Use the ◀/▶ buttons to place the cursor under the digit of the IP address displayed to be set and use +/− to set the IP address wished.
- Press the **MODE** button.
→ The "Setting the address of the gateway" – "**IP-GATEWAY**" menu is activated.

Setting the address of the gateway

The address of a gateway (server) can be set in this menu. If no gateway is used you can skip this setting.

- Use the ◀/▶ buttons to place the cursor under the digit of the IP address displayed to be set and use +/− to set the IP address wished.

Bx 4	IP-GATEWAY
192.168.	0. 1

- Press the **MODE** button.
→ The "Setting the UDP port" – "**UDP-PORT**" menu is activated.

Setting the UDP port

The UDP port setting is required if the cassette needs to be reached externally to make the setting, such as from another input frequency. This setting is intended for future functions and can be skipped for this cassette.

Bx 4	UDP-PORT
6000	

- Use the ◀/▶ buttons to place the cursor under the digit of the port number displayed to be set and use +/− to set the port number wished ("0" ... "65535").

- Press the **MODE** button.
- The "Selecting the input signal path" – "**INROUTE**" menu is activated.

Selecting the input signal path

In this menu you define the signal path of the input transport streams.

- Menu setting "**A = 1 B = 2**" (page 7).
- Menu setting "**A+B = 1 2 = OFF**" (page 7).

Bx 4	INROUTE
A=1	B=2

- Use the **+/-** buttons to select the signal path wished.
- Press the **MODE** button.
- The "Selecting the output signal path" – "**OUTROUTE**" menu is activated.

Selecting the output signal path

In this menu you define the signal path of the output transport streams.

- Menu setting "**1 => MA 2 => MB**" (page 8).
- Menu setting "**1 => ASI MA => OFF**" (page 8).
- Menu setting "**2 => ASI MB => OFF**" (page 8).

Bx 4	OUTROUTE
1=>MA	2=>MB

- Use the **+/-** buttons to select the signal path wished.
- If you do not want to do ASI settings, press the **MODE** button.
- The "Selecting the channel strip" – "**LINE**" menu is activated (page 25).
- To set the ASI parameters press the **MULTI** button.
- The "Setting the ASI transfer rate" – "**ASI RATE**" menu is activated.

Setting the ASI transfer rate

In this menu you set the output transfer rate for the ASI component connected. For this setting please take the required information from the documentation (technical data) of the ASI component to be connected.

Bx 4	ASI RATE
100000 KBits	

- Use the **◀/▶** buttons to place the cursor under the digits to be set for the transfer rate then use the **+/-** buttons to set the transfer rate wished.
- Press the **MODE** button.
→ The "Setting the ASI options" – "**ASI OPTION**" menu is activated.

Setting the ASI options

In this menu you define the size of the data packets, their polarity and the type of transmission.

For this setting please take the required information from the documentation (technical data) of the ASI component to be connected.



Bx 4	ASI OPTION
188	pos. cont.

- Press the **+/-** buttons to set the size of the data packets ("188" or "204" bits).
- If the polarity of the data to be transmitted has to be changed, press the **◀/▶** buttons to place the cursor under "**pos.**" (positive – standard) and using the **+/-** buttons set to "**neg.**" (negative).
- To change the type of transmission press the **◀/▶** buttons to position the cursor under "**cont.**" (continuous – standard) and using the **+/-** set to "**burst**".
→ Setting "**cont.**"
The data packets of the user data are collected to a great data packet in the transport stream.
→ Setting "**burst**"
The data packets of the user data are spaced out evenly in the transport stream.

- Press the **MODE** button.
- The "Selecting the channel strip" – "**LINE**" menu is activated.

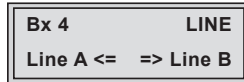
Selecting the channel strip



- By pressing  select channel strip "**A**" ("**Line A**") or select channel strip "**B**" ("**Line B**") by pressing the  button.
- The "Selecting channel / frequency setting" – "**OUTPUT**" menu is activated.

Selecting channel / frequency setting

In this menu, you can choose the channel or frequency setting for the adjustment of the HF output. The channel setting covers the range of channels C5 ... C12 and C21 ... C69, the frequency setting covers the range from 42.0 MHz to 860.0 MHz.



The COFDM signal is normally transmitted with a bandwidth of 8 MHz. This means that you can only use the channel centre frequency of the existing channel grid in the range of channels C21 ... C69 (frequency grid 8 MHz). The CCIR channel grid is 7 MHz in the range of the lower frequency bands (channels C5 ... C12). If 8 MHz COFDM signal packages are transmitted in these channel ranges, this will result in interference (overlapping) and transmission problems.

For programming in these channel ranges and in the frequency ranges below them, we recommend to reduce the bandwidth of the COFDM signal to 7 MHz (page 36).

Please note thereby that many receivers cannot receive the channel ranges 306 ... 466 MHz (S21 ... S41).



- Use **+**/**-** to select channel setting "**Channel**" or frequency setting "**Freq.**".
- Press the **MODE** button.
→ The "Setting the output channel" or "Setting the output frequency" – "**OUTPUT**" menu is activated.

Setting the output channel

In this menu you set the output channel of the channel strip (C5 ... C12, C21 ... C69). Additionally the modulator of the channel strip can be switched off or on (page 26).

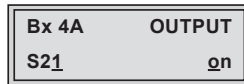

- Use the **+**/**-** buttons to set the output channel.

Setting the output frequency

In this menu you set the output frequency of the channel strip (42.0 ... 860.0 MHz). Additionally the modulator of the channel strip can be switched off or on (page 26).

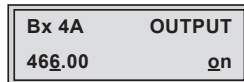

- Use the **◀**/**▶** buttons to place the cursor under the digit to be set for the frequency display then use **+**/**-** to set the output frequency wished.

Switching the modulator off or on

- To switch off the modulator place the cursor under "**on**" using the **▶** button and switch "**off**" the modulator of the channel strip using the **+**/**-** buttons.
→ The switched off modulator is indicated by " - - - " in the display instead of the channel or frequency display.
→ The status LED of the channel strip "**A**" is switched off (see page 15).
- In the case the modulator is switched "**off**" use the **+**/**-** to switch it "**on**".

- Press the **MODE** button.
- The "Adjusting the output levels of the channel strips" – "**LEVEL**" menu is activated.

Adjusting the output levels of the channel strips

This menu item is used to set the output levels of the modulators of the channel strips "**A**" and "**B**" to the same value.



- Measure and note down the output level of the channel strip.
 - By repeatedly pressing the **AUDIO** button scroll back to the "Selecting the channel strip" menu.
 - Select the other channel strip (page 25) and set the following menu items:
 - "Selecting channel / frequency setting", page 25.
 - "Setting the output channel" or "Setting the output frequency", page 26.
 - Switch on the modulator if necessary, page 26.
 - Measure and note down the output level.
 - Activate the "**LEVEL**" menu of the channel strip with the higher output level.
 - By pressing **+/-** adjust the higher output level of the one channel strip to the lower output level of the other channel strip incrementally ("**0**" ... "**-10 dB**").
- Press the **MODE** button.
 - Channel strip "**A**":
The "Selecting the input transport stream" – "**INPUT**" menu is activated.
 - Channel strip "**B**":
The "Switching the IP address off or on, selecting the transmission protocol, setting the port number" – "**MODE / PORT**" menu is activated (page 28).

Selecting the input transport stream

In this menu you select the signal source for the selection of the services. The transport streams to be processed are provided by the tuner of channel strip "A" and the LAN interface "Lan".



- Press the **+**/**-** buttons to select the signal source of the input transport stream ("Lan", "Tuner").
- Press the **MODE** button.
 - Setting "Lan":
The "Switching the IP address off or on, selecting the transmission protocol, setting the port number" – "**MODE / PORT**" menu is activated.
 - Setting "Tuner":
The "Setting the LNB oscillator frequency" – "**LNB**" menu is activated.
Continue with chapter "Setting the HF receiving stage", page 44.

Switching the IP address off or on

Selecting the transmission protocol

Setting the port number

In this menu you can switch off or on the IP address of the transport stream fed via the LAN interface and define the transmission protocol and the port number.

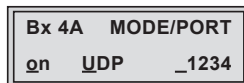

These settings are not necessary in the channel strip "B" if "**A+B=1 2=OFF**" is set in the "**INROUTE**" menu.







Switching the IP address off or on

- Press the **+**/**-** buttons to switch "**off**" or "**on**" the IP address of the transport stream fed via the LAN interface, if necessary.

Selecting the transmission protocol

- Press the  button to position the cursor under "**UDP**" or "**RTP**".
- Using the  /  buttons to select the transmission protocol wished:
"**UDP**" – The User Datagram Protocol is for the connectionless transmission of data to a certain application. The port number of the service is also sent which the data should obtain.
"**RTP**" – The Real-time Transport Protocol is for continuously transmitting multimedia data streams in an IP network. Unlike UDP, the header is transmitted which makes the data transmission more robust.





Setting the port number

- Press the  button to position the cursor under the port number e.g. "**_1234**".
- Use the  /  buttons to position the cursor under the digit of the port number displayed to be set.
- Using the  /  buttons set the port number wished.
- Press the **MODE** button.
→ The "Setting the IP address of the input transport stream" – "**IN-IP**" menu is activated.

Setting the IP address of the input transport stream

In this menu you can set the IP address of the transport stream fed via the LAN interface.

Bx 4A	IN-IP
227. 40. 50. 6 <u>0</u>	

- Use the  /  buttons to position the cursor under the digit of the IP address displayed to be set.
- Using the  /  buttons set the IP address wished.
- Press the **MODE** button.
→ The "Setting the station filter" – "**PROGRAM**" menu is activated.

Setting the station filter

The default setting for the station filter is **"off"**. In this menu you define the services received to be transmitted. If services are activated the output symbol rate increases.

If the station filter is switched off (factory default) all services of the transport stream passes the station filter. As soon as the station filter is activated all services are inactive and can be added to the transport stream selectively.

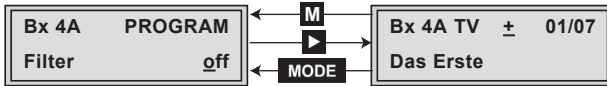

The figures of the menus below are dependent on the setting of the "Selecting the input signal path" menu (page 23).

"INROUTE" menu setting "A = 1 B = 2"

- Press the **+/-** button.

—> All services from the channel strip will be read, and then displayed with name and type of the service.

—> If no service is found, the following message will appear in the display: **"FILTER no Service"**.

In this case, check the configuration of the antenna system and the head-end station, as well as the previously adjusted settings for the cassette and the components connected to the LAN input.

—> The display shows e.g.: **Bx 4A TV + 01/07**
Das Erste

Meaning of the indicators in the example:

"**Bx 4A**" Slot 4, channel strip "A"

"**TV**" "Television" (type of service)

"**+**" The currently selected service is activated.

"**01/07**" The 1st of 7 services is being displayed.

"**Das Erste**" Name of the service

Further possible terms displayed:

"RA" "Radio" (type of service)

For radio stations, the background of the screen of the connected TV or test receiver is darkened.

" - " The currently selected service is switched off.

" * " A star means that the service selected is encoded. To enable the service, the CA module and the appropriate smart card of the provider are required.

→ If a service number (e.g. "131") appears instead of "TV" or "RA", this indicates that an unnamed service or an undefined transport stream is being received.

- Use the ◀/▶ buttons to call up the services in sequential order, then use +/- to activate (indicated by " + ") or to remove them (indicated by " - ").

→ Pressing the **MULTI** button all services can be activated or deactivated.

- Press the **MODE** button.

→ The filter is activated.

The display shows "**PROGRAM Filter on**".

→ If services are activated the corresponding PIDs (audio, video, text) are inserted into the transport stream and the PAT and SDT tables are updated.

→ If all services are activated the station filter remains switched off "**PROGRAM Filter off**".

Test the status of the individual services:

- If the filter is switched on, press the ▶ button. In this mode you can test the settings of the station filter again or change them if necessary.

- In the "**PROGRAM Filter on**" menu the station filter switched on can be switched "**off**" using the buttons +/- if necessary.

"INROUTE" menu setting "A+B = 1 2 = OFF"

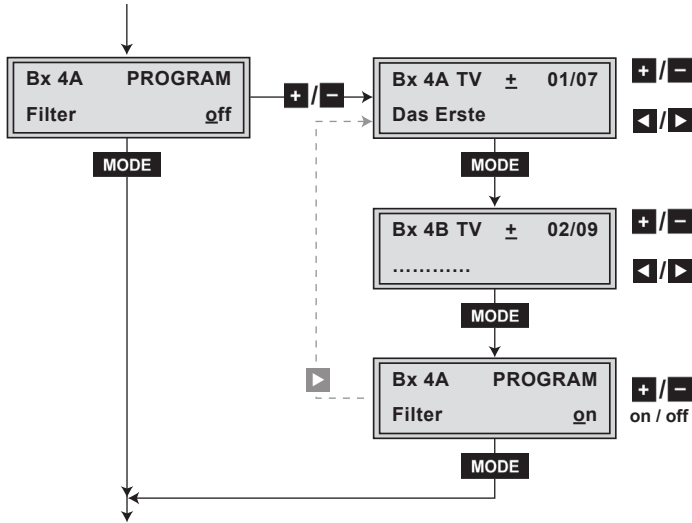

- Set the channel strip "A" or "B".
 - The setting of the station filters for the channel strips "A" and "B" is identical and follows the description above.
- Press the **MODE** button.
 - The "Setting the output signal" – "**COFDM-MODE**" menu is activated when the channel strips "A" without a CA module installed and "B" are programmed. Please take note of the tables below before setting the COFDM parameters.
 - Programming the channel strip "A" with a CA module installed the "Setting the PID monitoring" – "**CA**" menu is activated (page 47).

COFDM parameters

The tables below show the dependence of the transmittable net data rate on the settings of the COFDM parameters.

		Net data rate [kbit/s] at a bandwidth of 8 MHz			
		Guard interval			
Modulation	Code rate	1/4	1/8	1/16	1/32
QPSK	1/2	4976	5529	5853	6031
	2/3	6635	7372	7805	8041
	3/4	7464	8294	8780	9047
	5/6	8294	9215	9756	10052
	7/8	8708	9676	10244	10554
16 QAM	1/2	9952	11058	11708	12063
	2/3	13270	14745	15611	16085
	3/4	14929	16588	17563	18095
	5/6	16588	18431	19514	20105
	7/8	17417	19352	20490	21111
64 QAM	1/2	14929	16588	17563	18095
	2/3	19905	22117	23417	24127
	3/4	22394	24882	26344	27143
	5/6	24882	27647	29272	30159
	7/8	26126	29029	30736	31667

If the bandwidth is decreased by 1 MHz the transmittable data rate is lowered by approx. $\frac{1}{8}$.

		Net data rate [kbit/s] at a bandwidth of 7 MHz			
		Guard interval			
Modulation	Code rate	$\frac{1}{4}$	$\frac{1}{8}$	$\frac{1}{16}$	$\frac{1}{32}$
QPSK	$\frac{1}{2}$	4354	4838	5122	5276
	$\frac{2}{3}$	5805	6450	6828	7036
	$\frac{3}{4}$	6531	7257	7683	7915
	$\frac{5}{6}$	7257	8063	8536	8795
	$\frac{7}{8}$	7619	8466	8963	9235
16 QAM	$\frac{1}{2}$	8708	9676	10245	10555
	$\frac{2}{3}$	11611	12901	13659	14074
	$\frac{3}{4}$	13063	14514	15367	15833
	$\frac{5}{6}$	14514	16127	17074	17592
	$\frac{7}{8}$	15239	16933	17928	18471
64 QAM	$\frac{1}{2}$	13063	14514	15368	15833
	$\frac{2}{3}$	17417	19352	20490	21111
	$\frac{3}{4}$	19594	21772	23052	23750
	$\frac{5}{6}$	21772	24191	25613	26389
	$\frac{7}{8}$	22860	25400	26894	27708

		Net data rate [kbit/s] at a bandwidth of 6 MHz			
		Guard interval			
Modulation	Code rate	$\frac{1}{4}$	$\frac{1}{8}$	$\frac{1}{16}$	$\frac{1}{32}$
QPSK	$\frac{1}{2}$	3732	4147	4390	4523
	$\frac{2}{3}$	4976	5529	5853	6030
	$\frac{3}{4}$	5598	6220	6585	6784
	$\frac{5}{6}$	6220	6911	7317	7538
	$\frac{7}{8}$	6531	7257	7683	7915
16 QAM	$\frac{1}{2}$	7464	8294	8781	9047
	$\frac{2}{3}$	9952	11058	11708	12063
	$\frac{3}{4}$	11197	12441	13171	13571
	$\frac{5}{6}$	12441	13823	14635	15078
	$\frac{7}{8}$	13063	14514	15367	15832
64 QAM	$\frac{1}{2}$	11197	12441	13171	13571
	$\frac{2}{3}$	14929	16588	17563	18095
	$\frac{3}{4}$	16795	18661	19758	20357
	$\frac{5}{6}$	18661	20735	21953	22619
	$\frac{7}{8}$	19594	21772	23051	23750

	Transmission parameters for DVB-T at a bandwidth of 8 MHz											
Transmission mode	2k				4k				8k			
Symbol duration T_S [μ s]	224				448				896			
Carrier space Δf [kHz]	4.4643				2.232				1.116			
$(n_{\text{carrier}})_{\text{theoretical}}$	2048				4096				8192			
$(n_{\text{carrier}})_{\text{real}}$	1705				3410				6817			
Used bandwidth [MHz]	7.61				7.61				7.61			
Total symbol duration T_{GS} [μ s]	280	262	238	231	560	504	476	462	1120	1008	952	924
Guard interval T_G [μ s]	56	28	14	7	112	56	28	14	224	112	56	28
T_G / T_S	$1/4$	$1/8$	$1/16$	$1/32$	$1/4$	$1/8$	$1/16$	$1/32$	$1/4$	$1/8$	$1/16$	$1/32$

	Transmission parameters for DVB-T at a bandwidth of 7 MHz											
Transmission mode	2k				4k				8k			
Symbol duration T_S [μ s]	224				448				896			
Carrier space Δf [kHz]	4.4643				2.232				1.116			
$(n_{\text{carrier}})_{\text{theoretical}}$	2048				4096				8192			
$(n_{\text{carrier}})_{\text{real}}$	1705				3410				6817			
Used bandwidth [MHz]	6.66				6.66				6.66			
Total symbol duration T_{GS} [μ s]	320	288	272	264	620	576	544	528	1280	1152	1088	1056
Guard interval T_G [μ s]	64	32	16	8	128	64	32	16	256	128	64	32
T_G / T_S	$1/4$	$1/8$	$1/16$	$1/32$	$1/4$	$1/8$	$1/16$	$1/32$	$1/4$	$1/8$	$1/16$	$1/32$

	Transmission parameters for DVB-T at a bandwidth of 6 MHz											
Transmission mode	2k				4k				8k			
Symbol duration T_S [μ s]	224				448				896			
Carrier space Δf [kHz]	4.4643				2.232				1.116			
$(n_{\text{carrier}})_{\text{theoretical}}$	2048				4096				8192			
$(n_{\text{carrier}})_{\text{real}}$	1705				3410				6817			
Used bandwidth [MHz]	5.71				5.71				5.71			
Total symbol duration T_{GS} [μ s]	373	336	317	308	767	672	634	616	1493	1344	1269	1232
Guard interval T_G [μ s]	74.7	37.3	18.7	9.3	149	75	37.4	18.6	298.7	149.3	74.6	37.3
T_G / T_S	$1/4$	$1/8$	$1/16$	$1/32$	$1/4$	$1/8$	$1/16$	$1/32$	$1/4$	$1/8$	$1/16$	$1/32$

Setting the output signal

In this menu, you can set the bandwidth, the carrier modulation and the spectral position of the output signal.

Bx 4A COFDM-MODE
8MHz QAM64 POS

Bandwidth of the output signal

To transmit the output signal in the channel range of C21 to C69 a bandwidth of 8 MHz can be used.

In the channel range of C5 to C12 a bandwidth of ≤ 7 MHz must be set.

If frequency setting is selected you can set the bandwidth dependent on the frequency of the neighbouring-channel.

Bx 4A COFDM-MODE
8MHz QAM64 POS

- Use **+**/**-** to set the bandwidth of the output signal ("5 MHz" ... "8 MHz").

Carrier modulation

In this menu item the carrier modulation is set. At this the setting "QPSK" corresponds to the lowest and the setting "QAM64" to the highest output data rate.

- Use the **◀**/**▶** buttons to place the cursor under "QPSK / QAM...".
- Set the carrier modulation of the output signal using the **+**/**-** buttons ("QPSK", "QAM16", "QAM64").

Spectral position

For exceptional cases and "older" digital cable receivers, the spectral position of the user signal can be inverted "NEG" (negative). The default setting is "POS" (positive).

- Use **◀**/**▶** to place the cursor under "POS".
 - Use **+**/**-** to set the spectral position to "NEG".
- Press the **MODE** button.
→ The "Setting the transmission parameters" – "COFDM-MODE" menu is activated.

Setting the transmission parameters

In this menu you can set the transmission modes, the code rate and the guard interval.

Bx 4A COFDM-MODE		
8k	C7/8	G1/32

Transmission mode

In this menu item you set the quantity of carriers:

2k mode: 1512 carrier for user data (total 1705 carriers)

4k mode: 3024 carrier for user data (total 3410 carriers)

8k mode: 6048 carrier for user data (total 6817 carriers)

—> The standard modes for DVB-T are 2k and 8k.

- Using the **+**/**-** buttons set the transmission mode required ("2k" ... "8k").

Code rate

During a transmission data can be lost or changed. To recover this data redundancy is added to the signal to be transmitted (forward error correction). The factor of the quantity of redundancy contained in the bits transmitted is called code rate.

Using the setting "C7/8" you can get the highest output data rate at lowest redundancy.

- Use the **◀**/**▶** buttons to place the cursor under "C...".
- Set the code rate required using the **+**/**-** buttons ("C1/2", "C2/3", "C3/4", "C5/6", "C7/8").

Guard interval

In this menu item you set the relation of the duration of the user symbols to the duration of the guard intervals to be transmitted. A high guard interval, e.g. "G1/4" causes a low output data rate. For cable networks the setting "G1/32" is adequate.

- Use the **◀**/**▶** buttons to place the cursor under "G...".
 - Set the guard interval required using the **+**/**-** buttons ("G1/4", "G1/8", "G1/16", "G1/32").
- Press the **MODE** button.
- > The "Setting the transmitter identification" – "COFDM TPS" menu is activated.

Setting the transmitter identification

At terrestrial transmission an identification is referred to each COFDM modulated transmitter. When COFDM modulated signals are fed into cable networks this identification is not necessary usually. If receiving problems should occur you must refer a transmitter identification (CELL ID) to each output channel and switch "on" the transmitter identification.

Bx 4A	COFDM TPS
CELL 0x0000	off

- Use the ◀/▶ buttons to position the cursor under the digit of the hexadecimal number to be set.
 - Press +/- to set the respective digit of the hexadecimal number.
 - Repeat the procedure by the quantity of the digits to be set.
 - Using the ▶ button place the cursor under "off" and switch "on" the transmitter identification using the +/- buttons.
- By pressing the ◀ button you return to the hexadecimal number setting.
- Press the **MODE** button.
- The "Displaying the output data rate" – "STUFFING" menu is activated.

Displaying the output data rate

This menu shows the output data rate defined using the COFDM settings and the current output data rate.

Bx 4A	STUFFING
31667	(28352)

Number 1 Number 2

31667 (= "Number 1"): Defined net output data rate

(28352) (= "Number 2"): The current measured output data rate.

If the station filter is set correctly, this value is lower than the value of the "Number 1". The value fluctuates, since the data rates of individual services are dynamically modified by the broadcasters.

- "Number 2" is not displayed in the channel strips "A" or "B" at the settings "**OUTROUTE 1=>ASI MA=OFF**" or "**2=>ASI MB=OFF**", for the data rate of the ASI input signal cannot be measured. The ASI input signal therefore must be built in such a way so that the output data rate ("Number 1") is not exceeded.
- The data rate of the transport stream built by the cassette in the channel strip "A" can be measured at the setting "**OUTROUTE 1=>MA 2=>MB**" and be displayed in the channel strip "A".
- Is the "Number 2" higher than "Number 1" question marks "??" appear in the display. In this case correct the COFDM settings (pages 36 ... 38) or the settings of the station filter (page 30).

Bx 4A	STUFFING
31667	(36906) ??

- Press the **MODE** button.
- The "Setting a substitute signal" – "**FAILURE**" menu is activated.

Setting a substitute signal

You use this menu to set whether a COFDM signal filled with "**Null Packets**", a COFDM signal filled with null packets and self-made tables "**Tables**" or a "**Single Carrier**" signal should be provided as an output signal whenever an incorrect input signal occurs. Self-made tables are transmitted furthermore.

Bx 4A	FAILURE
Null Packets	

- Use the **+ / -** buttons to set the output signal required.
- Press the **MODE** button.
- The "Setting the transport stream / ORGNET-ID" – "**TS/ONID**" menu is activated.

Setting the transport stream / ORGNET-ID

If the stations of a transponder are split into the transport streams of the channel strips "A" and "B", one of the both transport streams a new identification (ORGNET-ID) must be allocated to realise the channel search of the set-top boxes connected without mistakes.

If the ORGNET-ID is changed a new NIT must be generated.

Bx 4A	TS/ONID
0x0001,0100	off

- Use the ◀/▶ buttons to position the cursor under the digit of the hexadecimal number to be set.
 - Press +/- to set the respective digit of the hexadecimal number.
 - Repeat the procedure by the quantity of the digits to be set.
 - Using the ▶ button place the cursor under "off" and switch "on" the transmitter identification using the +/- buttons.
- By pressing the ◀ button you return to the hexadecimal number setting.

- Press the **MODE** button.
- The "Network Information Table" – "NIT" menu is activated.

Network Information Table (NIT)

Bx 4A	NIT
off	=> Make

- To switch NIT on/off ("on"/"off") press the +/- buttons.
- Press the ▶ button to activate NIT ("Make").



All active ...-COFDM /...-QAM cassettes must be set and ready for reception. The NIT of all ...-COFDM /...-QAM cassettes are switched on.

The cassette fetches all the information (output frequencies, output data rates, etc.) it needs from all the ...-COFDM / ...-QAM cassettes in order to generate the NIT. This process may take a few seconds. Then the NIT is generated, added and sent to all ...-COFDM / ...-QAM cassettes. The other ...-COFDM / ...-QAM cassettes also add this new NIT. The status of all ...-COFDM / ...-QAM cassettes in the NIT menu changes to "on".

The display shows: "**read ... / copy ...**".

- To switch off the new NIT ("**off**") press the **[-]** button.



→ The NITs of the other ...-COFDM / ...-QAM cassettes will remain switched on. When the NIT of the cassette is switched on again ("**on**") by pressing the **[-]** button, the previously generated NIT is added again. If you have changed parameters in the meantime, you must first select "**Make**" to generate a new, up-to-date NIT.

- Press the **MODE** button.

→ The "Setting the network/operator identification" – "**CAT-ID**" menu is activated.

Setting the network/operator identification

In this menu, you can change the network/operator identification (CAT-ID – Conditional Access Table - Identification), for example of the visAvision transponder (Eutelsat 8° West).

Bx 4A	CAT-ID
0xDE00	off

CAT is not to be changed:

- Press the **MODE** button.
- The "Deleting a PID" – "**DROP**" menu is activated (page 42).

Changing the CAT:

The network operator e.g. requires that you set the operator ID of the visAvision transponder to "2".

- Use the **◀/▶** buttons to position the cursor under the digit to be set.
- Use **+/[-]** to change the operator ID from "**0xDE00**" to "**0xDE02**".
- Use the **▶** button to position the cursor under "**off**," then use **+/[-]** to activate the new CAT ("**on**").

→ The menu display switches to "**modified**".

→ If you try to change the network/operator identification (operator ID) of a transponder which cannot be modified, "**not modified**" appears in the display.

- Press the **MODE** button.
- The "Deleting a PID" – "**DROP**" menu is activated.

Deleting a PID

In this menu a PID of the transport stream can be deleted.

Bx 4A	DROP
PID 0x0000	off

- Use the **◀/▶** buttons to place the cursor under the respective digit of the hexadecimal number of the PID to be deleted ("0x0000") and set the hexadecimal number using **+/-**.
- Use the **▶** button to set the cursor under "off" and delete the PID using the **+/-** buttons ("on").
- Press the **MODE** button.
- The "Renaming a PID" – "**REMAP**" menu is activated.

Renaming a PID

In this menu you can allocate a new address to a PID retaining the complete data content.

Bx 4A	REMAP
0x0000 -> 0000	off

- Use the **◀/▶** buttons to place the cursor under the respective digit of the hexadecimal number of the PID to be changed ("0x0000") and set the hexadecimal number using **+/-**.
- Use the **◀/▶** buttons to place the cursor under the respective digit of the hexadecimal number of the new PID ("-> 0000").
- Set the hexadecimal number using **+/-**.
- Use the **▶** button to set the cursor to "off" and rename the PID using the **+/-** buttons ("on").
- Press the **MODE** button.
- The "Factory reset" – "**FACTORY Defaults**" menu is activated.

Factory reset

In this menu you can reset all settings to the factory defaults.

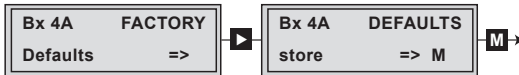

- Press the **▶** button.
 - The factory defaults are invoked ("**FACTORY STORE**").
 - By pressing the **MODE** button, you will be returned to the menu item "Selecting the channel strip" **without** invoking the factory defaults (page 24).
- Press the **M** button.
 - The factory defaults are saved. The display shows "STORE"
 - Back to "Selecting the cassette" (page 20).
 - By pressing the **MODE** button, you will be returned to the menu item "Selecting the channel strip" **without** saving the factory defaults (page 25).
 - If necessary set channel strip "**B**".

Saving settings

- Press the **M** button.
 - The settings are saved.
 - You will be returned to the menu item "Selecting the cassette" via connection **(A)** (page 20).
 - If functions of the TPS module are activated, their status is shown in the second line of the menu:
 - "**M**" – The station filter is switched on.
 - "**N**" – NIT is activated.
 - "**C**" – The network/operator identification CAT is activated.
 - By pressing the **MODE** button, you will be returned to the menu item "Selecting the channel strip" via connection **(B)** **without** saving the programmed data (page 25).
 - If necessary set channel strip "**B**".

5.3.1 Setting the HF receiving stage

Setting the LNB oscillator frequency

Set the oscillator frequency of the LNB used in this menu.



- Using the **MULTI** button the oscillator frequencies "10600" or "9750" can be selected directly.
- To set other LNB oscillator frequencies use the **◀/▶** buttons to place the cursor under the digit of the LNB oscillator frequency displayed to be set.
- Press **+/-** to enter the respective digit of the oscillator frequency of the LNB used.
- Repeat the procedure by the quantity of the digits to be set.
- Press the **MODE** button.
→ The "Setting the input symbol rate, setting the DVB mode" – "**SYMBOL**" menu is activated.

Setting the input symbol rate

Setting the DVB mode

The symbol rates of the satellite transponders can be found in the current channel table of the satellite operator, in various satellite magazines and in the Internet.

The cassette recognizes the transmitted DVB mode and switches over between the normal QPSK mode (DVB-S) and the DVB-S2 mode. Receiving stations with DVB-S2 mode, we suggest to preset the DVB mode to shorten the time for searching stations.

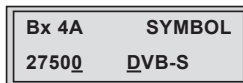

Setting the input symbol rate

- Using the **MULTI** button the symbol rates "27500" or "22000" can be selected directly.
- To set other symbol rates use the **◀/▶** buttons to position the cursor under the digit of the symbol rate displayed to be set.

- Press **+/ -** to enter the respective digit of the symbol rate needed.
- Repeat the procedure by the quantity of the digits to be set.

Setting the DVB mode

- Use the **▶** button to place the cursor under "**DVB-S**" and select the required DVB-S2-mode with the buttons **+/ -** .
- Press the **MODE** button.
 → The "Setting the input frequency" – "**FREQ**" menu is activated.

Setting the input frequency

If three dots " ... " appear in the second line of the display, the cassette is in the "**station search**" mode. Please wait until the process has finished.

Once the HF receiver has synchronised to the input signal, any offset to the target frequency is displayed in MHz, e.g. "**- 1.8**" in the middle of the second line of the display.

If a question mark "?" appears in the second line of the display, there is no input signal present. In this case check the configuration of the antenna system and head-end station as well as the preceding settings of the cassette.

Bx 4A	FREQ
11836	-1.8 CN 12

- Use **◀/▶** to position the cursor under the digit of the frequency displayed to be set.
- Press **+/ -** to set the respective digit of the input frequency needed.
- Repeat the procedure by the quantity of the digits to be set.
- Set the frequency offset shown in the display (e.g. "**- 1.8**") to less than 1 MHz by varying the input frequency using the **+/ -** buttons.
 → The display e.g. "**CN 12**" shows the signal to noise ratio of the signal received.
- Press the **MULTI** button.
 → The "Testing the signal to noise ratio" – "**C/N**" menu is activated.

Testing the signal to noise ratio

In this menu you can estimate the quality of the SAT IF input signal.

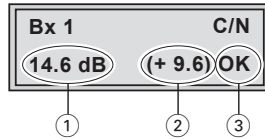

- ① Current signal to noise ratio
- ② This value shows the difference between the quality of the input signal and the threshold of the tuner at this type of modulation.
At a value lower than "5" picture dropouts can occur.
- ③ If "OK" is shown, the signal to noise ratio is ok.
If a value < 5 is shown under ② the display changes from "OK" to "??".
In this case test the input signal.



- In addition to the indicator in the display, there is also a status LED which indicates the quality of the received transport stream (level and C/N).
- If the LED lights yellow the SAT IF input level and the signal to noise ratio must be checked.

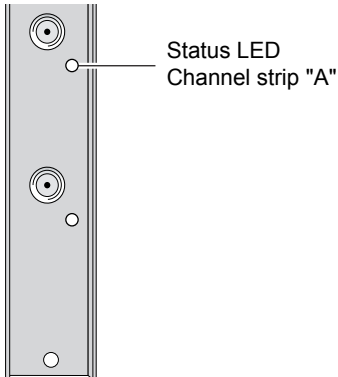

LED indicator	Indication
Green	Signal quality is good
Yellow	Signal quality is insufficient
Red	No signal
Off	The channel strip (modulator) is switched off

- Press the **MULTI** button to return to the main menu.
- Press the **MODE** button.
 - The "Setting the station filter" – "**PROGRAM**" menu is activated.
Continue with the programming procedure as described from page 30 on.

5.3.2 Operation with a CA module

In order for this function of the CA module to be possible, stations / services capable of being descrambled by the CA module and the smart card you are using must be selected in the "Setting the station filter" – "**PROGRAM**" menu of channel strip "**A**" (page 30).

Where both scrambled and unscrambled services are transmitted via a single channel, short-term picture loss may occur when switching between scrambled and unscrambled services.

Setting the PID monitoring

The factory default of the PID monitoring is switched on. If particular PIDs are not descrambled the CI module is reset. Additionally dropouts may occur if several services are descrambled. To prevent this the PID monitoring can be switched off.

Bx 4A	CA
PID Check	<u>on</u>

- Use the **+**/**-** buttons to switch "**off**" or "**on**". the PID monitoring.
- Press the **MODE** button.
→ The "Configuring the CA module" – "**CA**" menu is activated.

Configuring the CA module

The menu varies according to which CA module you are using. For this reason, please refer to the operating manual of your particular CA module. The relevant information is shown in the display of the head-end station. This may appear as a fixed display or as scrolling text according to display capabilities.

Bx 4A	CA
Menu <=	=> Edit

- By pressing the **MODE** button you can skip the "Configuring the CA module" – "**CA**" menu and activate the "Setting the output signal" – "**COFDM-MODE**" menu (page 36).
- Press the **◀** button to activate the menu of the CA module.

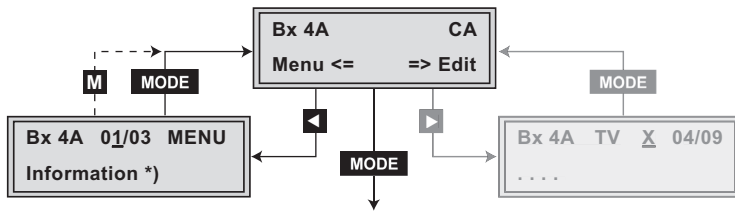

→ The display shows e.g.: **Bx 4A 01/03 MENU
Information**

Meaning of the indicators:

"**Bx 4A**" – Slot 4, channel strip "A"

"**01/03**" – The first of three menu items is activated.

"**MENU**" – The menu of the CA module is activated.

For the explanation of further details please use the operating instructions of the CA module used.

- Use the **+/-** buttons to activate the menu desired.
- Press the **▶** button to activate the menu.
- Use the **+/-** buttons to select the function desired.
- To set the CA module use the **◀/▶** and **+/-** buttons.
- All settings are saved by pressing the **M** button.

→ You will be returned to the "Configuring the CA module" – "**CA**" menu item.

→ By pressing the **MODE** button you can cancel the settings in the menu of the CA module and are returned to the "Configuring the CA module" – "**CA**" menu.

- Press the **▶** button.

→ The "Decoding services" – "**Edit**" menu is activated.

Descrambling services

In this menu you select the services wished from the scrambled data stream, which are to be descrambled.

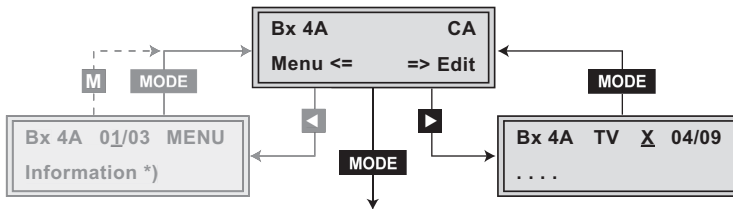

→ The display shows e.g.: **Bx 4A TV X 04/09**

.....

Meaning of the indicators in the example:

"**Bx 4A**" – Slot 4, channel strip "A"

"**TV**" – "Television" (type of service)

"**X**" – Descrambling is set for the currently selected station.

"**04/09**" – The 4th of 9 services is being displayed.

". . . ." – Name of the service

Further possible terms displayed:

"**RA**" – "Radio" (type of service)

"**0**" – The currently selected service remains unchanged.

- Use the ◀/▶ buttons to call up the services in sequential order which are to be descrambled, then use +/– to descramble ("X") or not to descramble them ("0").
- Press the **MODE** button to save changes and activate the filter.
→ The filter is activated. The display shows the "Configuring the CA module" – "CA" menu.



- Press the **MODE** button.
→ The "Setting the output signal" – "**COFDM-MODE**" menu (page 36).

6 Final procedures



After installing the head-end station, upgrading accessories or installing cassettes it is necessary to tighten all cable connections, cable terminals and cover screws in order to maintain compliance with current EMC regulations securely.

- Securely tighten the cable bolted connections fingertight using an appropriate open-ended spanner.
- Measure the output levels of the other cassettes and tune them to a uniform output level using the appropriate level controls or software dependent on the head-end station used. Please regard the assembly instructions of the respective head-end station.
 - > In order to prevent interference within the head-end station and the cable system, the output levels of the digital cassettes must be set lower by 8 dB compared to analogue cassettes.
- Mount the front cover (see assembly instructions of the head-end station).

7 Channel and frequency tables

Advice for a frequency grid (8 MHz) in the band I/III

Frequency [MHz]	Frequency [MHz]	Frequency [MHz]	Frequency [MHz]	Frequency [MHz]	Frequency [MHz]
42.00	82.00	146.00	186.00	226.00	266.00
50.00	114.00	154.00	194.00	234.00	274.00
58.00	122.00	162.00	202.00	242.00	282.00
66.00	130.00	170.00	210.00	250.00	290.00
74.00	138.00	178.00	218.00	258.00	298.00

Channel-/frequency grid for DVB-T (band III, bandwidth 7 MHz)

Kanal Channel	Frequency [MHz]	Kanal Channel	Frequency [MHz]	Kanal Channel	Frequency [MHz]
C 5	177.5	C 8	198.5	C 11	219.5
C 6	184.5	C 9	205.5	C 12	226.5
C 7	191.5	C 10	212.5		

CCIR – Hyperband (frequency grid 8 MHz)

Kanal Channel	Kanalmittefrequenz Channel centre frequency [MHz]	Kanal Channel	Kanalmittefrequenz Channel centre frequency [MHz]	Kanal Channel	Kanalmittefrequenz Channel centre frequency [MHz]	Kanal Channel	Kanalmittefrequenz Channel centre frequency [MHz]	Kanal Channel	Kanalmittefrequenz Channel centre frequency [MHz]
S 21	306.00	S 26	346.00	S 30	378.00	S 34	410.00	S 38	442.00
S 22	314.00	S 27	354.00	S 31	386.00	S 35	418.00	S 39	450.00
S 23	322.00	S 28	362.00	S 32	394.00	S 36	426.00	S 40	458.00
S 24	330.00	S 29	370.00	S 33	402.00	S 37	434.00	S 41	466.00
S 25	338.00								

CCIR – Band IV/V (frequency grid 8 MHz)

C 21	474.00	C 31	554.00	C 41	634.00	C 51	714.00	C 61	794.00
C 22	482.00	C 32	562.00	C 42	642.00	C 52	722.00	C 62	802.00
C 23	490.00	C 33	570.00	C 43	650.00	C 53	730.00	C 63	810.00
C 24	498.00	C 34	578.00	C 44	658.00	C 54	738.00	C 64	818.00
C 25	506.00	C 35	586.00	C 45	666.00	C 55	746.00	C 65	826.00
C 26	514.00	C 36	594.00	C 46	674.00	C 56	754.00	C 66	834.00
C 27	522.00	C 37	602.00	C 47	682.00	C 57	762.00	C 67	842.00
C 28	530.00	C 38	610.00	C 48	690.00	C 58	770.00	C 68	850.00
C 29	538.00	C 39	618.00	C 49	698.00	C 59	778.00	C 69	858.00
C 30	546.00	C 40	626.00	C 50	706.00	C 60	786.00		

Service:

Phone: +49 (0) 911 / 703 2221
Fax: +49 (0) 911 / 703 2326
Email: service@gss.de